

# **RONGTA** User Manual

## **58MM THERMAL RECEIPT PRINTER**

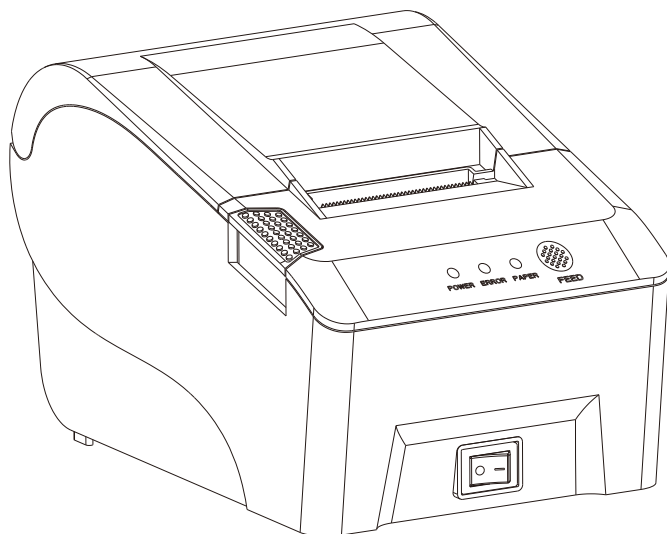

# Contents

---

---

I. Product Introduction .....	2
1.1 Safety Warnings .....	2
1.2 Main Features .....	2
II. Safety Instructions.....	3
III. Appearance and Components .....	4
IV. Technical Parameters .....	8
4.1 Printing Parameters.....	8
4.2 Printer Indicators.....	9
4.3 Printer Interfaces.....	9
V. Installation and Operation of Printer .....	10
5.1 Printer Unpacking.....	10
5.2 Connecting the Printer.....	10
5.3 Loading Paper .....	11
5.4 Bluetooth pairing and printing.....	12
5.5 Use Bluetooth interface for printing .....	12
VI. The Switch, Key and Indicator Light of Printer.....	13
6.1 Power Switch .....	13
6.2 Keys and Indicators .....	13
VII. Self-Test of Printer .....	14
VIII. Serial Interfaces of Printers.....	15
IX. Parallel Interfaces of Printers .....	16
X. USB Interface .....	17
XI. Ethernet Interfaces of Printers.....	18
XII. Cashbox Interfaces of Printers.....	19
XIII. Cleaning the Printer .....	20
13.1 Cleaning the Printer Head.....	20
13.2 Cleaning the Sensor.....	20
13.3 Cleaning the Printing Rubber Roller.....	21
XIV. Troubleshooting .....	22
XV. Driver Installation .....	23
15.1 Installation for Windows .....	23
15.2 The Port Direct Drive .....	23

# I. Product Introduction

---

---

Thank you for purchasing the 58 mm thermal receipt printer produced by our company. This thermal receipt printer provides you with safe, reliable and efficient printing quality at a reasonable economic price. At the same time, RP58 is widely used in supermarkets, hospitals, restaurants, banks, gas stations, road and bridge toll collection and other fields due to its super functions and easy operation.

## 1.1 Safety Warnings

- ⚠ Warning:** Do not touch the paper cutting knife or paper-tearing knife of the printer.
- ⚠ Warning:** The print head is a heating component. Do not touch the print head and its surrounding components when the printer is still warm in temperature.
- ⚠ Warning:** Do not touch the surface of the thermal print head and connectors, to avoid electrostatic damage to the print head.
- ⚠ Warning:** This product is only suitable for the use in non-tropical climates.

## 1.2 Main Features

- High printing quality
- Low noise
- Support cashbox drive
- The attractive appearance
- Reasonable structure, simple use and maintenance
- Built-in data buffer that receives print data when printing
- USB port, parallel port, serial port, or Ethernet port can be selected for communication.
- The characters can be enlarged, bolded, underlined. And it can adjust the line spacing and the left-right spacing for printing.
- Supports bitmap downloading and graphic printing with different densities
- Realize high-speed printing equivalent to calling built-in and cartridge font in the mode of driver printing (dot map)
- Low power consumption and low operation cost (color tape and ink cartridge are not required)
- It is compatible with ESC/POS print instruction set

## II. Safety Instructions

---

---

**Before operating and using the printer, please carefully read the following items and strictly observe the use rules.**

- ① Please install the printer on a stable surface to avoid printer suffered from any vibration and shocks.
- ② Stop using keeping the product in any case of unusual circumstances such as the presence of high temprature, high humidity and serious pollution.
- ③ Connect the printer's power adapter to an appropriate grounding socket. Avoid using the same socket with large motors or other equipment that may cause voltage fluctuation of power supply.
- ④ Do not get the product wet. Do not insert foreign objects(e.g. metal) into the product, and once it occurs, immediately turn off the power supply.
- ⑤ Never use the printer without paper, otherwise it will seriously damage the printing rubber roller and thermal head.
- ⑥ Unplug the product from the power outlet if the printer is idle for a long time.
- ⑦ Do not disassemble or modify the product personally.
- ⑧ Use only the power adapter specified in this instruction.
- ⑨ In order to ensure the printing quality and prolong the service life of the product, it is recommended to use the recommended or equivalent thermal printing paper.
- ⑩ Do not plug/unplug the product with the product powered on.
- ⑪ When plugging and unplugging the printer power cord, please hold the arrow position of the printer power connector with your hand, not the cord of the printer power cord.
- ⑫ Please keep this manual for the future use and reference.

# III. Appearance and Components

## RP58 thermal receipt printer

### Front View

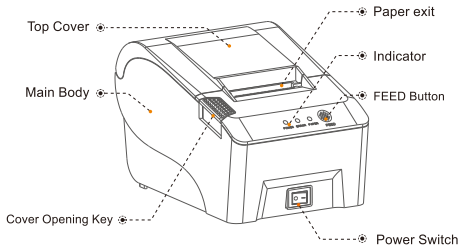

### Rear View

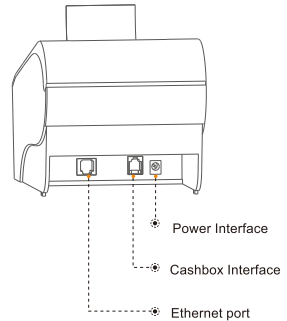

### Inside View

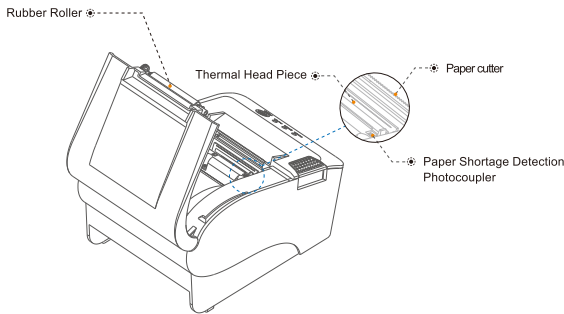

## Application Field

- ECR POS system receipt printing
- Query/service system receipt printing
- EFT POS system receipt printing
- Measuring instrument information printing
- Sports, postal and civil aviation receipt printing
- Tax receipt and bill printing

# RP58A thermal receipt printer

## □ Front View

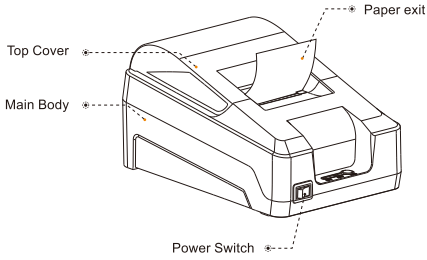

## □ Rear View

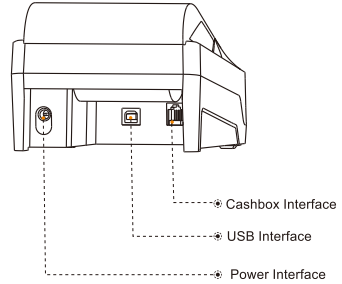

## □ Inside View

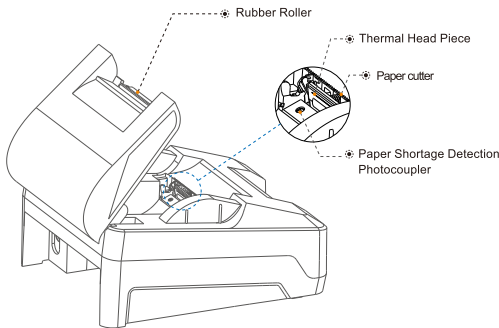

## Application Field

- ECR POS system receipt printing
- Query/service system receipt printing
- EFT POS system receipt printing
- Measuring instrument information printing
- Sports, postal and civil aviation receipt printing
- Tax receipt and bill printing

# RP58B thermal receipt printer

## Front View

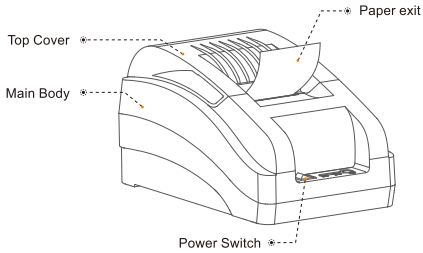

## Rear View

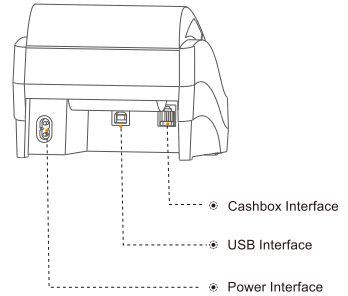

## Inside View

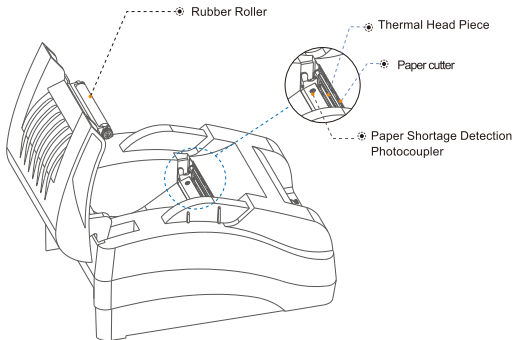

## Application Field

- ECR POS system receipt printing
- Query/service system receipt printing
- EFT POS system receipt printing
- Measuring instrument information printing
- Sports, postal and civil aviation receipt printing
- Tax receipt and bill printing

# RP58E thermal receipt printer

## □ Front View

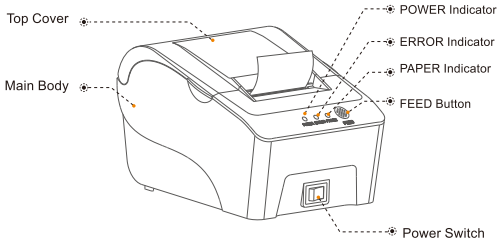

## □ Rear View

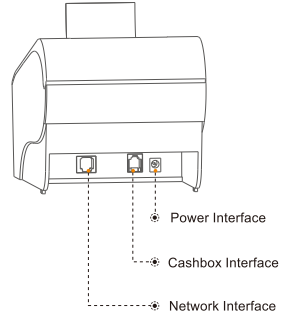

## □ Inside View

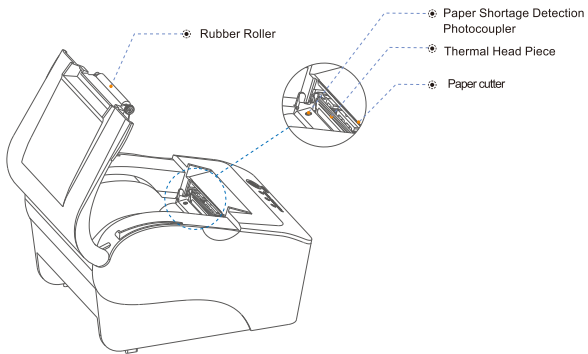

## Application Field

- ECR POS system receipt printing
- Query/service system receipt printing
- EFT POS system receipt printing
- Measuring instrument information printing
- Sports, postal and civil aviation receipt printing
- Tax receipt and bill printing



# IV. Technical Parameters



## 4.1 Printing Parameters

Model	RP58\RP58A\RP58B\RP58E
Printing method	Thermal line printer
Printing speed	90mm/s MAX
Printing paper width	57.5±0.5 mm
Effective resolution	203 dpi
Outside diameter of paper roll	RP58: φ80mm(MAX) RP58A: φ50mm RP58B: φ60mm RP58E: φ75mm(MAX)
Thickness of printing paper	0.06-0.08mm
Effective printing width	48mm
Dot density	384dot/line
Character size	ASCII Font A: 12x24 ASCII Font B: 9x17 Chinese character 24x24
Line space	3.75mm(Use the command to adjust the line space)
Size of receive buffer	2KBytes

### Print character

ASCII character set	12x24 dot, 1.25 (width)X3.00 (height)mm
National Standard Class I and II Chinese Character Font	24x24 dot, 3.00 (width)X3.00 (height)mm
Type of bar code	One-dimensional code : UPC-A,UPC-E,EAN-13,EAN-8,CODE39, ITF, CODEBAR, CODE93, CODE128; QR code: QR CODE.
Extended character table	PC437、Katakana、PC850、PC860、PC863、PC865、WPC1252、PC866、PC852、PC858 etc., 10 international languages in total

### Power supply

Power adapter	AC 100 ~ 240V
Input power supply	DC 12V  2.0A/ DC 8.5V  2.0A
Cashbox output	DC 12V  1A

### Service life

Service life	The service life of print head ( Remove the thermal printer mechanism): 50 kilometers
--------------	--

### Environmental requirements

Working environment	Operating temperature: 0~ 45°C, operating humidity: 20~90%
Storage environment	Storage temperature:-10 ~ 60°C, storage humidity: 10~90%

### Environmental conditions

Drive	WIN2003/WINXP/WIN7/WIN8/WIN10
Print command	ESC/POS command compatible
Character printing	It supports double width and double height printing of AN K characters, custom characters and Chinese characters; adjusts dot patterns of character spacing for printing;
printing of dot patterns	It supports printing of dot patterns with different densities and downloaded graphics

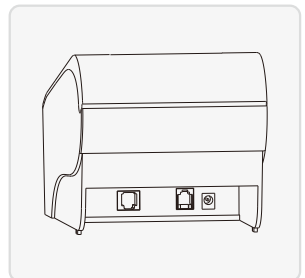
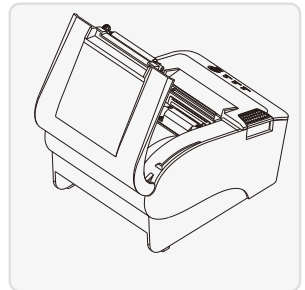
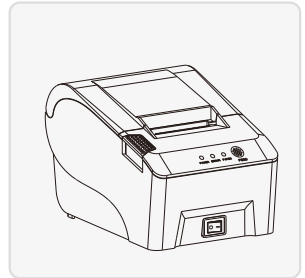



 The pictures are for reference only, please subject to practicality

## 4.2 Printer Indicators

<b>Type of printing paper</b> Thermal paper rolls recommended	Thermal printing paper
<b>Type of paper rolls</b>	Specifications: AF50KS-E Manufacturer: Jujo Thermal Oy(Finland) Specifications: TF-50KS-E Manufacturer: Nippon Paper Industries Co., Ltd  <b>⚠ Attention</b> (1) To get the best results from the printer, choose the recommended paper or other paper with equivalent quality, otherwise the printing quality will be affected and even the service life of thermal print head will be reduced. (2) Please do not use the paper roll that the end glued on the core of the paper roll, otherwise it may cause damage to the printer. (3) If the printing paper is contaminated by chemicals or oils, it may fade or reduce the sensible heat degree, and affect the printing effect. (4) Do not rub the surface of the printing paper with hard articles, otherwise it may cause fading. (5) The print paper will fade if the temperature is up to 70°C, keep it out of direct sunlight, humidity and high temperature.

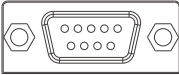
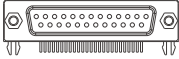
## 4.3 Printer Interfaces

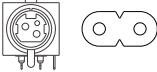
Diagram	Type	Illustration
	USB	Universal USB Interface (Standard Type B)
	Serial interface	Db9 female connector interface, communication baud rate is 4800bps, 9600bps, 19200bps or 38400bps optional (adjusting via DIP switch), data structure is parity-free, 8-bit data bit, 1-bit stop bit; RTS/CTS and XON/XOFF handshake protocols are supported
	Parallel interface (25PIN)	25PIN /Parallel (male connector) bidirectional parallel interface, 8-bit parallel interface, support BUSY/nAck handshake protocol 8
	Network interface	Standard RJ45-8P interface, 10M/100M transmission speed with self-adaptation, 100M network LED indication, data communication LED indication.
	Cashbox control	The 6-wire RJ-11 socket, outputting DC 12V/1A power signal to drive the cashbox.
	Power interface	DC power plug: DC 12V/DC 8.5V AC power plug: AC 220V/AC100~240V

⊙ **Note:** The interface is optional or customized, and the specific interface is subject to the actual object.

## V. Installation and Operation of Printer

### 5.1 Printer Unpacking

#### Check the parts:

Before use, make sure the accessories are included in the package(the following picture is an example). If any thing is missing, contact the supplier or manufacturer. The specific accessories may not be included depending on the printer model.

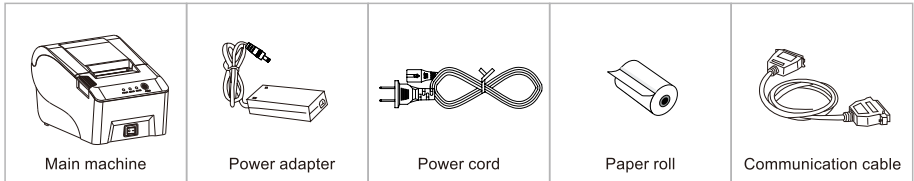

☺ The pictures are for reference only, please subject to practicality

### 5.2 Connecting the Printer

- (1) Make sure that both the printer and the PC host are turned off, plug the matching data communication cable into the printer's data interface, and plug the other end into the serial port/parallel port /USB/ network port of PC host.
- (2) If equipped with an electrically openable cashbox, insert the RJ-11 connector on the cashbox into the cashbox interface of the printer (the specifications of the cashbox must conform to the printer cashbox drive specifications).
- (3) Connect to the special power adapter of the printer.

**Use the special power adapter for the printer.**

**The connection diagram is as follows:**

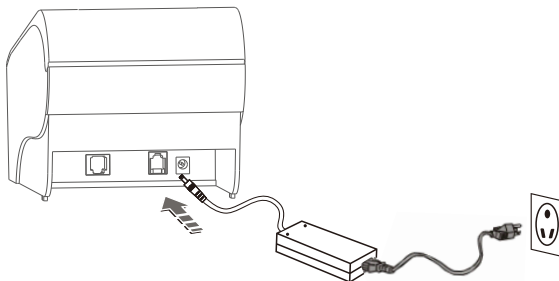

## Attention:

- (1) First plug the power plug DC24V of the printer, then switch on the AC220V power supply, (Or connect AC 220V/AC 100V~240V according to the power interface type) and then turn on the power switch. Do not reverse the sequence, otherwise the machine will be damaged.
- (2) Using an improper power adapter will make the printing quality worse and even damage the printer.
- (3) Do not connect the telephone line to the cashbox interface, otherwise the printer and telephone may be damaged.
- (4) When plugging in the printer power cord, please hold the arrow position of the printer power connector with your hand (do not plug in the cord of the printer power cord with your hand). Forcibly plucking the flexible cord of the printer power connector or pulling the printer power cord may cause damage to the printer or the power adapter.

## 5.3 Loading Paper

The 58mm thermal receipt printer uses 58mm thermal paper rolls and adopts an easy paper loading mechanism, which is very convenient for paper loading.

### The Installation Method of Thermal Paper is as Follows:

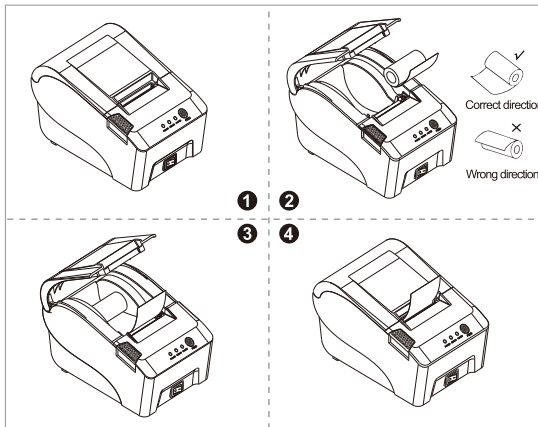

- (1) Open the upper cover of the printer (figure 1).
- (2) Insert the roll paper as shown in the 2 illustration.
- (3) Pull out a part of paper, and close the cover as shown in the 3 and 4 illustration.
- (4) Tear off the paper with the cutter (figure 4).

## 5.4 Bluetooth pairing and printing (only valid for printers with Bluetooth)

The RP58 series Bluetooth printer needs to be paired with the main device driving the printer before working, and the pairing process is initiated by the main device. The general pairing method is as follows:

- (1) Turn on the printer.
- (2) The main device searches for external Bluetooth device.
- (3) If there are multiple external Bluetooth device, select the printer corresponding to BDA address (see self-test page for details).
- (4) Enter the initial password "0000" or "1234".
- (5) Complete the pairing.

Please refer to the Bluetooth function description of the main device for the specific pairing method. When pairing, the RP58 series thermal receipt printer with Bluetooth interface must be on.

**⚠ Note: During pairing, please do not turn on multiple printers at the same time, otherwise you may not be able to judge which printer was successfully paired.**

After successful pairing, other host computers can still be paired with the printer, and each printer can be paired with up to 8 host computers. If more upper computers are paired with printers, the host computer paired with the printer at the earliest will be automatically removed from the pairing list by the printer. At this time, if this host computer needs to drive the printer for printing, it needs to be paired again.

(For multi-connected Bluetooth only)

## 5.5 Use Bluetooth interface for printing (only valid for the printers with Bluetooth)

For host computers with virtual Bluetooth serial ports (such as mobile phones using SMARTPHONE, POCKET PC, PALM, notebook computer, etc.), after successful pairing, printing data can be sent to the printer via the virtual Bluetooth serial port for printing. If the host computer does not have a virtual Bluetooth serial port, when you want to drive the printer for printing, please consult the supplier of the host computer.

## VI. The Switch, Key and Indicator Light of Printer

### 6.1 Power Switch

The power switch controls the flow of power to the printer. The power switch is located in front of the printer. When the "I" switch is pressed, the printer is turned on; When the "O" of the switch is pressed, the printer is turned off.

**⚠ Attention: Make sure the power supply is connected before turning on the printer.**

### 6.2 Keys and Indicators

The indicator of RP58\RP58E printers is a tri-color indicator, while that of RP58A\RP58B is a bi-color indicator.

□ The keys and indicator panel as shown in the following figure:

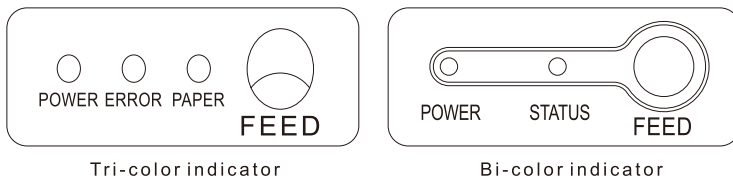

□ The function description of keys and indicators:

Press the FEED button once to advance paper or hold down the FEED button to feed paper continuously.

Hold down the FEED button and turn on the product at the same time to print the self-test.

Tri-color indicator	Bi-color indicator	Indicator	Status
POWER Light (Green)	POWER Light (Green)	POWER Indicator	It is always on when connected to the power supply
ERROR Light (Red)	STATUS Light (Red)	ERROR Indicator	The ERROR indicator will flash in case of printer error, such as paper shortage, paper jam, overheating of print head, print head error or other abnormalities.
PAPER Light (Red)		PAPER Indicator	The PAPER indicator is always on in case of paper shortage and goes out if paper is detected by the paper shortage sensor.

## VII. Self-test of Printer

---

---

Self-test can detect whether the printer is working normally. If the Self-test list sample can be printed correctly, it indicates that everything is normal except the connection interface with the host computer, otherwise overhaul is required. In the self-test, it will print the software version number, print density, interface type, English characters and some Chinese characters in sequence.

The operation method of self-test is: after the printer is connected, press and hold the feed key first and then turn on the power supply of the printer. First, the printer will reset and detect, and release the feeding button less than 5 seconds after the reset is completed. At this moment, the printer will carry out self-test and print the self-inspection list sample.

**The printer prints the following content after self-test:**

**Selftest**

**\*\*\*\*\***

**\*\* Completed \*\***

## VIII. Serial Interfaces of Printers

The serial interface of 58mm thermal receipt printer adopts RS-232 standard. The communication baud rate is 4800bps, 9600bps, 19200bps or 38400bps optional (adjusting via DIP switch). It is parity-free, 8-bit data bit, 1-bit stop bit; RTS/CTS and XON/XOFF handshake protocols are supported.

**The functions of each pin of the printer serial interface are defined as follows:**

Pin number	Model	Signal source	Description
2	TXD	Printer	The printer sends data to the host.
3	RXD	Host	The printer receives data from the host.
8	RTS	Printer	This signal reflects the current status of printer. A high electrical level indicates that the printer is "busy" and cannot receive data, while a low electrical level indicates that the printer is "ready" and can receive data.
5	GND	-----	Signal ground
6	DTR	Printer	Same as RTS signal (pin 8).

**Schematic diagram of connection between printer serial interface and POS host serial interface:**

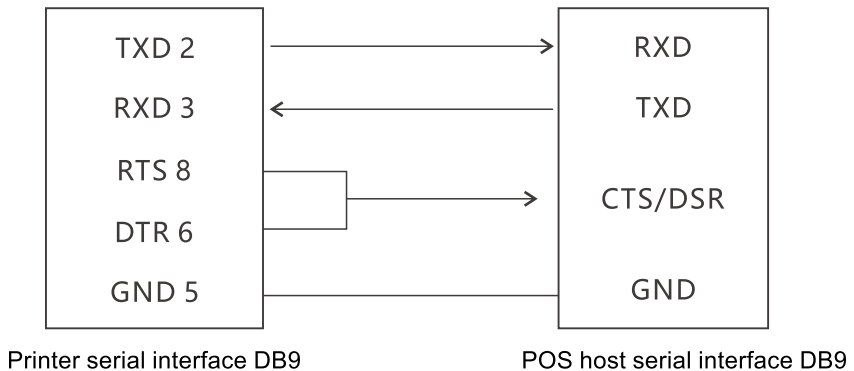



## IX. Parallel Interfaces of Printers

The parallel interface socket of the 58mm thermal receipt printer is a 25 parallel socket with 8-bit parallel transmission, it supports BUSY/nAck handshake protocol (subject to the actual object).

**The functions of each pin of printer parallel interface socket are defined as follows:**

Number of 25 PIN	Number of 36 PIN	Signal name	Signal source	Description
1	1	/STB	Host	Data strobe trigger pulse, read data at falling edge
2	2	DATA2	Host	These signals respectively represent the first to eighth bit information of parallel data. The signal is "high" electrical level when the logic is "1" and "low" electrical level when the logic is "0".
3	3	DATA3	Host	
4	4	DATA4	Host	
5	5	DATA5	Host	
6	6	DATA6	Host	
7	7	DATA7	Host	
8	8	DATA8	Host	
9	9	DATA9	Host	
10	10	nAck	Printer	Printer response signal. It indicates that the printer has received the data of previous byte
11	11	BUSY	Printer	"High" electrical level indicates that the printer is "busy" and cannot receive data.
12	12	Paper-out	-----	It indicates whether there is a paper shortage Paper-out PE.
13	13	Select	Printer	Pull up electrical level to "high" by resistor
18-25	16-17	GND	-----	Ground, logic "low" electrical level
	19-30	GND	-----	Ground, logic "low" electrical level
	33	GND	-----	Ground, logic "low" electrical level
15	32	NError(nFault)	Printer	Pull up electrical level to "high" by resistor

## X. USB Interface

---

---

The printer's USB interface socket is standard USB type-B

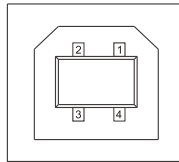

PIN	SIGNAL NAME
1	VBUS
2	D-
3	D+
4	GND

## XI. Ethernet Interfaces of Printers

---

The Ethernet interface socket of 58mm thermal receipt printer is standard RJ45-8P, it supports 10M/100M network, and the transmission speed is adaptive.

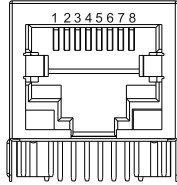

Pin number	Description	Illustration
1	TX+	Send differential line+
2	TX-	Send differential line-
3	RX+	Receive differential line+
4	NC	No function
5	NC	No function
6	RX-	Receive differential line-
7	NC	No function
8	NC	No function

## XII. Cashbox Interfaces of Printers

The cashbox interface of the printer adopts RJ-11 standard, 6-wire socket, and outputs DC 24V/1A power signal to drive the cashbox. Insert the RJ-11 crystal connector of the cashbox into the cashbox interface to open the cashbox through the printer.

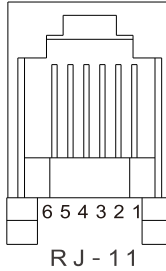

**The functions of each pin of the cashbox interface of the printer are defined as follows:**

Pin number	Signal	Description
1	NC	NC
2\5	Dk1	Negative pole of cashbox 1#
3	NC	NC
4	PWR	Positive pole of power supply/cashbox
6	NC	NC

☺ **Note:**Select the above interface definition and buy cashbox.

## XIII. Cleaning the Printer

---

### 13.1 Cleaning the Printer Head

**Clean the print head when one of the following conditions occurs to the printer:**

- (1) Printing is not clear;
- (2) A vertical column of the printed page is not clear;
- (3) The paper feeding noise is high.

**The print head cleaning steps are as follows:**

- (1) Disconnect the power cord, open the upper cover and remove the paper if exists.
- (2) If printing has just been completed, wait for the print head to cool completely;
- (3) Clean the printer head with a soft cotton moistened with ethyl alcohol.
- (4) After waiting for absolute ethyl alcohol to volatilize completely, close the cover and try printing again.

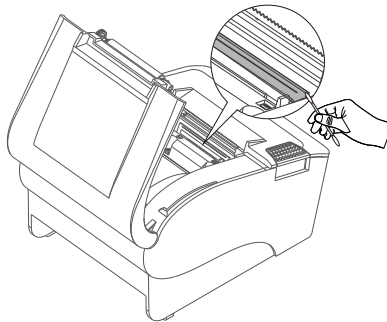

### 13.2 Cleaning the Sensor

**Clean the paper shortage sensor when one of the following conditions occurs to the printer:**

- (1) In the printing process, the printer occasionally stops printing and alarms for paper shortage;
- (2) It does not give alarms for paper shortage.

**The paper shortage sensor cleaning steps are as follows:**

- (1) Turn off the power supply of the printer, open the upper cover, and remove the paper if there is any;
- (2) Wipe off the dust and stain on the sensor surface with soft cotton cloth (which should be dried) dipped in absolute ethyl alcohol.
- (3) After waiting for absolute ethyl alcohol to volatilize completely, close the cover and try to start the machine again.

### 13.3 Cleaning the Printing Rubber Roller

**When one of the following conditions occurs to the printer, the printing rubber roller should be cleaned:**

- (1) Printing is not clear;
- (2) A vertical column of the printed page is not clear;
- (3) The paper feeding noise is high.

**The printing Rubber Rollers cleaning steps are as follows:**

- (1) Turn off the power of the printer and open the upper cover;
- (2) Use a soft cotton cloth (which should be dried) dipped in a neutral detergent to wipe off dust and stains on the surface of the printing rubber roller;
- (3) Close the upper cover after the cleaning agent is completely volatilized.

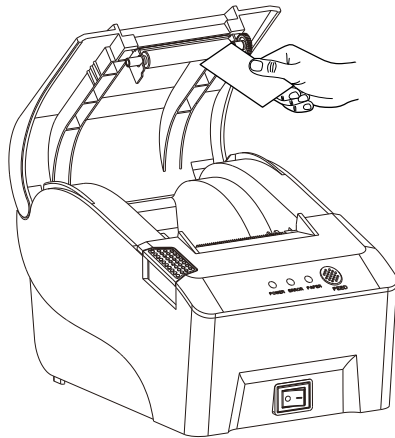

**⚠ Attention:**

- (1) The power supply must be turned off during the daily maintenance of the printer.
- (2) Do not touch the surface of the print head with hands and metal objects, and do not scratch the surface of the print head, printing rubber roller and sensor with tweezers and other tools.
- (3) The organic solvents such as gasoline and acetone shall not be used.
- (4) Wait until absolute ethyl alcohol is completely volatilized, then turn on the power supply to continue printing.

## XIV. Troubleshooting

---

---

When the printer fails, it can be handled according to the method in this section. If the problem cannot be solved, please contact the distributor or manufacturer.

### 14.1 The indicator on the control panel is not on

Check whether the power cord is properly plugged into the printer, power adapter, and power outlet or not. Check if the printer's power switch is on.

### 14.2 The indicator is normal, while the printer does not work

Run the self-test to check whether the printer can work properly. If you cannot perform self-test, please contact your distributor or the technical service personnel.

**If the self-test can be performed normally, check the following:**

- (1) Check the interfaces at both ends of the connection line between the printer and the computer. At the same time, confirm whether the connection meets the specifications of printer and computer.
- (2) The data transfer settings between the printer and the computer may be different. You can use self-test to print out the printer's interface settings. If the printer cannot print, please contact your distributor or the technical service personnel.

## **XV. Driver Installation**

---

---

There are two ways to drive the 58mm thermal receipt printer, one is to install the driver directly under Windows WIN2003/WINXP/WIN7/WIN8/WIN10, the other is to use the port for direct driving.

### **15.1 Installation for Windows**

Add the printer to Windows and assign the driver files in the driver disk to Windows. You can start printing only by calling the print command in the program. In this way, the printer driver of Windows actually converts characters into graphic dot matrix for printing.

### **15.2 The Port direct drive**

In this way, there is no need to use a driver, only the characters need to be directly output to the port, and the built-in and cartridge font inside the printer is used to realize the conversion and printing of the characters. Using the port direct drive way, the printing mode is also changed from page printing mode to line printing mode, making printing control more convenient. If the port direct drive mode is used, the instruction set needs shall be used to control the printing of the printer, and the ESC/POS command set has been integrated inside the 58mm thermal receipt printer.





**Rongta Technology (Xiamen) Group Co., Ltd.**

**ADD: No.88, Tonghui South Road, Tongan, Xiamen, China.**

**WEB: [www.rongtatech.com](http://www.rongtatech.com)**

**TEL: 0086-592-5666129    FAX: 0086-592-5659169**

